

CRUEL COMPONENTS

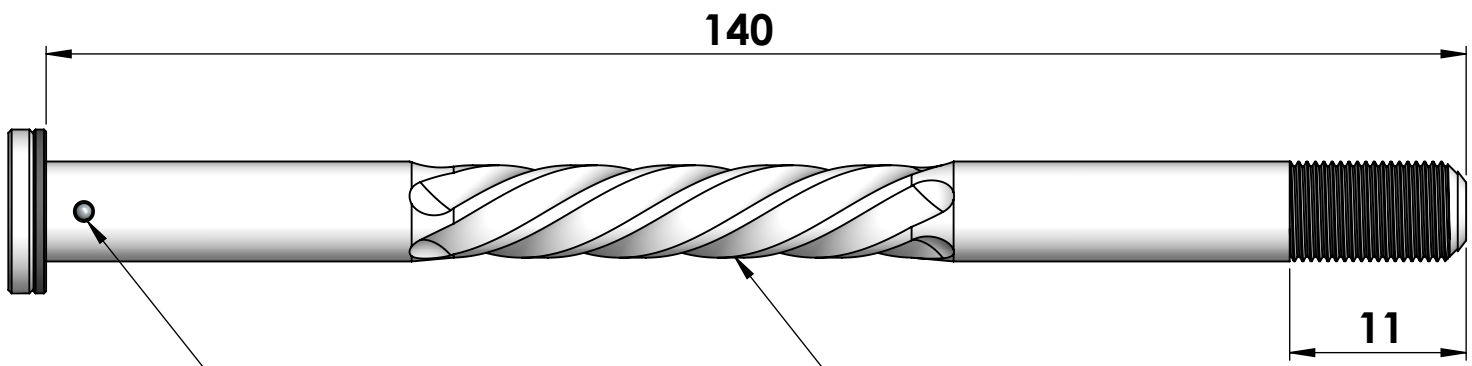

SPINA IN ACCIAIO TEMPRATO
HARDENED STEEL PLUG

SPIRALE DI ALLEGERIMENTO
LIGHTENING COIL

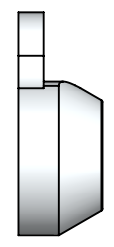

DADO UNI-8
UNI-8 NUT

LOGHI INCISI
ENGRAVED LOGOS

SISTEMA DI SICUREZZA ESAGONALE
SECURITY HEXAGONAL SISTEM

VITE IN TITANIO TORX T25
TORX T25 TITANIUM BOLT

DISTANZIALE ANTI-GRIPPAGGIO DELRIN
ANTI-SEIZE DELRIN SPACER



SISTEMA DI SERRAGGIO BREVETTATO
PATENTED TORQUING SYSTEM

RAT 140
ERGAL 7075-T6
TI °5
DELRIN